

YAESU

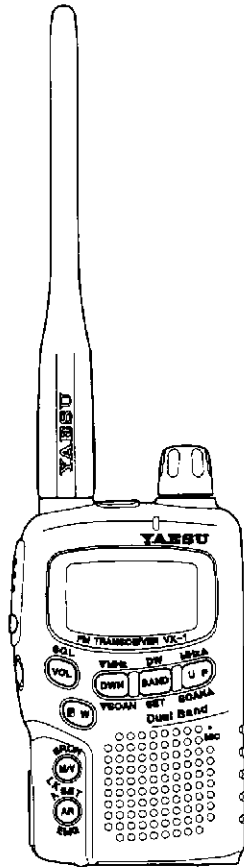

VX-1R

VHF/UHF Ultra-Compact
Dual-Band Transceiver
With Wide Band Coverage

downloaded by
www.radioamatore.info

YAESU

....leading the way.SM

YAESU MUSEN CO., LTD.

1-20-2 Shimomaruko, Ota-Ku, Tokyo 146-8649, Japan

YAESU U.S.A.

17210 Edwards Rd., Cerritos, CA 90703, U.S.A.

YAESU EUROPE B.V.

Snipweg 3, 1118DN Schiphol, The Netherlands

YAESU UK LTD.

Unit 12, Sun Valley Business Park, Winnall Trading Estate
Winchester, Hampshire, SO23 0LB, U.K.

YAESU GERMANY GmbH

Am Kronberger Hang 2, D-65824 Schwalbach, Germany

YAESU HK LTD.

11th Floor Tsim Sha Tsui Centre, 66 Mody Rd.,
Tsim Sha Tsui East, Kowloon, Hong Kong

Copyright 1997

Yaesu Musen Co., Ltd.

All rights reserved.

No portion of this manual
may be reproduced without
the permission of
Yaesu Musen Co., Ltd.

Printed in Japan

9901c-FA



CAUTION!

1. Changes or modifications to this device not expressly approved by Yaesu Musen could void the use's authorization to operate this device.
2. This device complies with part 15 of the FCC Rules. Operation is subject to the following two conditions; (1) this device may not cause harmful interference, and (2) this device must accept any interference including interference that may cause undesired operation.
3. The scanning receiver in this equipment is incapable of tuning, or readily being altered, by User to operate within the frequency bands allocated to the Domestic Public Cellular Telecommunications Service in Part 22.

This device complies with RSS-210 of Industry Canada. Operation is subject to the following two conditions; (1) this device may not cause interference, and (2) this device must accept any interference, including interference that may cause undesirable operation of the device.

- Hold both **Ⓜ** and **Ⓢ** while turning the power on, and when the display appears as shown here, release the two keys.



You can now resume operation; the Menu settings are reset to their factory defaults (see the chart on page 42).

Microprocessor “Hard” Reset

If the microprocessor must be completely reset, use this procedure. All memories are cleared, and the transceiver is restored to its factory default status.

- Turn the radio Off.

- Hold **Ⓢ** and **Ⓜ** while turning the radio on. The confirmation display appears as at right.



- Press **Ⓜ** momentarily to initialize the radio. The display changes to that shown at the right.



If the display does not change, press **Ⓜ** again momentarily.

Avoiding Internal Spurious Signals (“Birdies”)

Any transceiver capable of such wide frequency coverage can produce spurious receiver responses at an audible level on certain frequencies, because oscillators inside the radio operate on sub-harmonics of those frequencies within the receiving range of the transceiver. Rarely will this occur on a channel on which you wish to operate, but if this should happen, you can shift the clock frequency of the microprocessor in the VX-1R, to move the “beat” signal away from the channel you want to use. Here’s how to do this:

- Hold **Ⓜ** for 1 second to activate the SET mode.
- Press **Ⓢ** or **Ⓜ** to select Menu Item #21 *ELK5FT* (“Clock Shift”).
- Turn the Dial one click to change the display from *OFF* to *ON* (or vice versa).
- Press **Ⓜ** once more (momentarily) to save the new setting and exit.
- Now listen to channel that was previously experiencing interference. If the spurious signal was, indeed, being generated inside the VX-1R, it should have disappeared.





In Case of Trouble. . .

Most cases of erratic or improper operation can be traced to one of three problems:

- Low battery voltage or poor battery connections.
- Poor antenna connections.
- A microprocessor “glitch” possibly caused by a static discharge or other factors.

Checking the Battery Voltage

The battery voltage can be checked at any time using the SET mode.

- Hold  for 1 second to activate the SET mode.
- Press  or  to select Menu Item #30 **BATT.**
- The current battery voltage is displayed.
- To return to normal display, press  momentarily.

If the battery voltage is low, the battery may need recharging (FNB-52LI) or replacement (alkaline cell). After recharging, you may need to wait for a while to obtain an accurate voltage reading.

If the radio fails to turn on after replacing an alkaline cell, remove the battery from the radio, and check it with an external voltmeter. If the battery appears to be OK, check the FBA-20 battery holder for dirty contacts or some other factor which may be obstructing the flow of current from the battery to the radio.

Antenna Problems

The supplied antenna is very rugged, as is the SMA connector on the transceiver. When using a different antenna via an adapter, however, a poor connection could degrade performance.

If you suspect an antenna problem and are using an external or after-market antenna, try the original antenna supplied with the transceiver to determine whether the problem is with the other antenna.

Microprocessor Resetting

If the transceiver behaves erratically, it may have received a static pulse which has “confused” the microprocessor. Permanent damage probably has not occurred, and you may only need to reset the microprocessor to return the radio to its original defaults so you can resume operation. Two levels of resetting are available:

SET Mode Resetting

In some cases of confusing transceiver behavior, the problem may lie in an improper setting in the Menu System. To set the Menu System back to its original factory defaults, without affecting other settings such as the memories, use this procedure:

- Turn the transceiver Off.

Cloning

You can copy all memories and settings from one VX-1R to another by connecting the **MIC/EAR** jacks of the two transceivers (while turned off) using the optional CT-27 Cloning Cable, available from your Yaesu dealer.

Here is the Cloning procedure:

- After connecting the two radios while they are turned off, hold  while turning on the radio. Do this for both units.
CLONE appear on the LCDs.

- On the destination radio, press .
[-IN appears on the LCD.

- On the source radio, press .
[-OUT appears on the LCD and the cloning data transfers.

If there is a problem during the cloning process, *ERR* is displayed. Check your cable connections and battery voltage, and try again.

- If cloning is successful, turn both radios off and disconnect the CT-27. You can then turn the radios back on, and begin normal operation.

Packet Operation

The VX-1R can be used for Packet operation with the optional CT-44 cable (available from your Yaesu dealer) for interconnection to your TNC with one miniature and one micro-miniature phone plug, per the diagrams below.

The audio level from the receiver to the TNC may be adjusted by the SQL VOL key and the Dial, as with voice operation. The input level to the VX-1R from the

TNC should be adjusted at the TNC side. The input impedance is $2\text{k}\Omega$.

Be sure to turn the transceiver and TNC off before connecting the CT-44 cable, to prevent voltage spikes from possibly damaging the transceiver.

R. F. Says: Switch the Battery Saver OFF during Packet operation. See page 25.

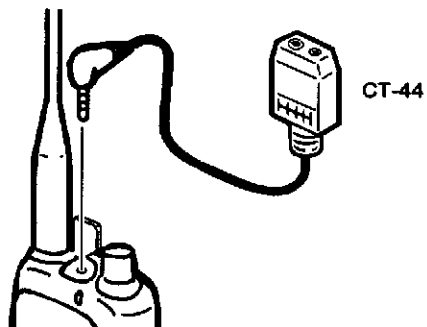

CT-44 Adapter

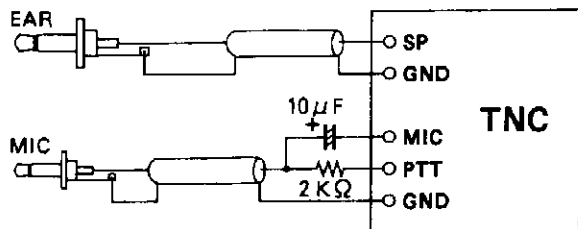

To CT-44 Adapter

SET Mode Summary (cont.)

No.	Title	Description	Default	Page
10	BEEP	Key Beeper (ON/OFF)	ON	27
11	ARTS BP	ARTS Beep Mode (RANG/ALL/OFF)	ALL	41
12	RX SAVE	Rx Battery Save OFF Time (200/300/500/1000/2000 ms/OFF)	200MS	25
13	APD	Automatic Power OFF Timer (OFF/30MIN or 1/3/5/8 Hr)	OFF	26
14	LOCK	Key Lock (KEY/DIAL/D+K/PTT/K+P/D+P/ALL)	KEY	26
15	BELL	# of Rings (OFF/1/3/5/8/REPEAT)	OFF	23
16	BSYLED	Busy/TX LED (ON/OFF)	ON	25
17	LAMP	LCD/Keypad Lamp Mode (KEY/5 SEC/TGL)	KEY	16
18	MON/TC	Function of MONI Switch (MONI/T-CALL)	MONI	23
19	TOT	Time Out Timer (OFF/1/2/5/10 Min.)	OFF	24
20	BCLO	Busy Channel Lock Out (ON/OFF)	OFF	25
21	CLKSFT	Shifting of CPU Clock Frequency (ON/OFF)	OFF	47
22	CW ID	ARTS CW ID (ON/OFF)	OFF	41
23	ID SET	ARTS CW ID Programming. See Character Set table.	J	41
24	SQLTYP	Tone/Squelch Mode (T/TSQ/DCS)	(Freq. dependent)	20, 21
25	T SET	CTCSS Tone Frequency Programming	Ham: 88.5 Hz; Others: 67.0 Hz	20
26	DCS	DCS Code Number Programming	023	21
27	DTMF	DTMF Autodialer Memory # (MANUAL, DTMF 1 - DTMF 8)	DTMF 1	28
28	SMT MD	Smart Search Sweep Mode (SINGLE/CONTI)	SINGLE	39
29	DIAL M	Operation Mode for Dial (DIAL/VOL-SQ)	DIAL	27
30	BATT	Checks Battery Voltage (Measured)	(Supply dependent)	46
31	BT MD	Band-Dependent Mode Setting (AUTO/MANUAL)	AUTO	17
32	RX MD	Rx Operating Mode (N-FM/W-FM/AM)	(Band dependent)	17

SET (Menu) Function Summary

Throughout this manual, the SET mode has been used to customize settings for your transceiver. Here is a summary of SET mode functions:



Entering the SET Mode

- Hold **BAND SET** for 1 second. The current Menu Item number and function name are displayed.
- Press **UP SCAN** or **DOWN SCAN** repeatedly to change Menu Items. There are 32 Menu Items available on the VX-1R, so use the key which allows the quickest navigation to the desired Menu Item.

- When you find the desired Menu Item, turn the Dial to change the current setting, if desired.
- When you are satisfied with the setting, Press **BAND SET** (or the PTT switch) momentarily to save the new setting and exit to normal operation.

SET Mode Summary

No.	Title	Description	Default	Page
1	<i>TX PWR</i>	Transmitter output (HIGH or LOW. Depends on power source)	<i>HIGH</i>	24
2	<i>NAME</i>	Frequency or Alphanumeric Label (FREQ, ALPHA)	<i>FREQ</i>	35
3	<i>NM SET</i>	Memory label entry. See Character Set table.	-----	35
4	<i>ARS</i>	Automatic Repeater Shift (ARS ON/ARS OFF)	<i>ARS ON</i>	18
5	<i>RPT R</i>	Repeater Shift Direction (-RPT/+RPT/SIMPLEX)	(Freq. dependent)	18
6	<i>SHIFT</i>	Repeater Shift Offset: 0.00 - 99.95 MHz	(Manual or ARS)	18
7	<i>STEP</i>	Channel Steps (5/10/12.5/15/20/25/50/100 kHz)	(Band dependent)	17
8	<i>RESUME</i>	Scan Resume Mode (5 SEC/CARRE)	<i>5 SEC</i>	36
9	<i>SCAN L</i>	Scan Stop Lamp (ON/OFF)	<i>ON</i>	38

ARTS Alert Beep Options

The ARTS feature offers a choice of beep options to alert you to the current status of ARTS operation (plus the option of turning them off). Depending on your location and the potential annoyance associated with frequent beeps, you can choose the Beep option that best suits your needs. The choices are:

- *RRNG*

Beeps sound only when the radio first detects that you are within range (when ARTS is first activated, and later after coming into range from an out-of-range condition).





- *ALL*

Beeps sound every time a polling transmission is received from the other station (every 15 seconds when in range). This is the default setting.

- *OFF*

No alert beeps sound; you must look at the display to determine current ARTS status.









You can set the ARTS Beep mode as follows:

- Hold  for 1 second to activate the SET mode.
- Press  or  to select Menu Item #11 *ARTS BP*.
- Turn the Dial to select the desired Beep mode, from the choices described above.
- Press  again (momentarily) to save the new setting and exit to normal operation.

CW Identifier Setup

The ARTS feature includes a CW identifier, as mentioned previously. The radio can be instructed to send “DE (*your callsign*) K” in Morse code every ten minutes during ARTS operation. The callsign may contain up to 8 characters from the table on page 35.

Here’s how to program and activate the CW IDER:

- Hold  for 1 second to activate the SET mode.
- Press  or  to select Menu Item #23 *ID SET*.
- Press  momentarily to clear any previous callsign.
- Turn the Dial to select the first letter/number of your callsign, and press  momentarily to save the first letter/number.
- Repeat the previous step as necessary to complete your callsign, pressing  after each entry (“*␣*” indicates the end of the string). While the callsign is displayed, you can play it back in the speaker by pressing  momentarily.
- Press  once momentarily to select Menu Item #22 *CW ID* if you have not yet activated the IDER.
- Turn the Dial one click to change the display from *OFF* to *ON*.
- Press  again (momentarily) to save the new settings of Menu Items 22 and 23.

ARTS (Automatic Range Transpond System)

The ARTS feature uses DCS signaling to keep two parties informed as to when they are within communications range and when they are not. This can be particularly useful in Search-and-Rescue or any other situation where is important to stay in contact with another station.

Both stations must set their DCS codes to the same code number, and activate their ARTS feature using the command appropriate for their radio. Alert ringers may be activated, if desired.

Whenever you push the PTT, or every 15 seconds after ARTS is activated, your radio transmits a (subaudible) DCS signal for about 1 second. If the other radio is in range, the beeper sounds (if enabled) and *IN RNB* (in range) is displayed in place of *OUTRNB* (out of range), with which ARTS operation begins.

Whether you talk or not, the radios continue to poll each other every 15 seconds while ARTS is activated. You can also have your radio transmit your callsign via CW every 10 minutes, to comply with identification requirements.





If you move out of range for more than one minute (four polls), your radio senses that no signal has been received. Three beeps sound, and the display reverts to *OUTRNB*. If you move back into range, your radio

again beeps, and the display changes back to *IN RNB*.

During ARTS operation, your operating frequency is not displayed, and you cannot change it or other settings; you must first terminate ARTS to resume normal operation. This is a safety feature to prevent accidental loss of contact due to channel change, etc.

Here is how to activate ARTS:

Basic ARTS Setup and Operation

- Press  momentarily, then press , to enter the ARTS Setup mode. This lets you set the DCS code to be used during ARTS operation.
- Turn the Dial to select the DCS code (matching the other station). After making your selection, press  momentarily to save the ARTS-DCS setting.
- Now press  again (momentarily). Your display changes to *OUTRNB* to indicate the beginning of ARTS operation. Every 15 seconds, your radio transmits a “polling” call to the other station. When that station responds with its ARTS polling signal, your display changes to *IN RNB* to confirm his response.
- Press  again momentarily to exit ARTS operation and resume normal operation.



R. F. Says: *ARTS won't work if you have used the Lock feature to disable the PTT!*

Smart Search Operation

Smart Search automatically stores the frequencies where activity is encountered on the selected band. When Smart Search is engaged, the radio quickly searches above and below your current frequency, storing active frequencies as it goes (without stopping on them even momentarily). These frequencies are stored in a special Smart Search memory bank, consisting of 31 memories (15 above the current frequency, 15 below the current frequency, and the current frequency itself).

Two Smart Search operating modes are available:

• “Single” Sweep



In this mode, the transceiver sweeps the current band once in each direction starting on the current frequency. All channels where activity is present (up to 15 in each direction) are loaded into the Smart Search memories. Whether or not all 31 memories are filled, the search stops after one sweep in each direction.

• “Continuous” Sweep







In this mode, the transceiver makes a sweep in each direction as with the One-Shot mode, but if all 31 channels are not filled after the first sweep, the radio continues sweeping until they *are* all filled.

Setting the Smart Search Mode

Hold  for 1 second to activate the SET mode.

- Press  or  to select Menu Item #28 *SMT MJ*.
- The display initially indicates *SINGLE* as the default mode. To change this to the “Continuous” mode, turn the Dial one click so the display indicates *CONTI*.
- Press  momentarily to save the new setting and exit to normal operation.

Storing Smart Search Memories

- Set the radio to the VFO mode in the desired band.
- Hold  for 1 second, then hold either  or  for 1 second to activate Smart Search scanning.
- As active channels are detected, the number of “loaded” memories is displayed at the upper left.
- Depending on the mode you set for Smart Search operation (Single or Continuous), the Smart Search scan eventually terminates, and the display reverts to the starting VFO frequency.
- To *recall* Smart Search memories, press  momentarily, then press  momentarily. Now you can turn the Dial (or press  or ) to select the Smart Search memories, or reinstate Smart Search (from the second step above).



R. F. Says: *Smart Search is a great tool when visiting a city for the first time. You don't need to spend time looking up repeater frequencies—just ask your VX-1R where the action is!*







- You can now turn the Dial or begin scanning. The transceiver behaves as though it is in the standard VFO mode, but operation is restricted to the range between Memories 1L and 1U.

Ten pairs of Band Limit memories, labeled 1L/1U through 10L/10U, are available.

Dual Watch (Priority Channel)



Dual Watch lets you watch for calls on a UHF "Priority" channel while receiving on other frequencies.

Before activating Dual Watch, you have to select a Priority channel on the U-HAM band:

- Press , as necessary, to select the U-HAM band.
- Store the frequency and any other settings for your Priority channel into any memory, if not already stored.
- Press  and  or , if necessary, to recall the memory you wish to make the Priority channel, and note its memory number.
- Hold  for 1 second to activate the memory write function, and complete the next step within 5 seconds.
- Turn the Dial to select the memory number of your Priority channel, then press  momentarily. **PRI** appears next to the memory number.

With the Priority channel stored, you can now change frequencies and bands as usual. Whenever you want

to monitor the Priority channel, activate Dual Watch as follows:

- From any band (except *BC BAND*), press  and then  momentarily.





DW appears near the lower left, and every 3 seconds the receiver jumps to the Priority channel (for 200 ms) to check for activity. If a call comes in on the Priority channel, the radio beeps and stops there until the channel is again clear.

Pressing  cancels Dual Watch, so you need to re-enable it when you change bands.

Automatic Lamp Lighting on Scan Stop





The LCD Lamp automatically lights whenever scanning pauses, so you can easily see the frequency of the incoming signal. Because this contributes to battery consumption, you may want to disable this "Scan Lamp" function (it is enabled by default).





The procedure for disabling the Scan Lamp is:

- Hold  for 1 second to activate the SET mode.
- Press  or  to select Menu Item #9 *SCAN L*.
- The display indicates *DW* as the default condition. Turn the Dial one click to select *OFF*.
- Press  once again (momentarily) to save the new setting and exit to normal operation.

Memory Scanning







Memory scanning is similarly easy to initiate:

- Select Memory mode by pressing  , if necessary.
- Hold  or  for 1 second to initiate scanning.
- As with VFO scanning, the scanner pauses on any signal strong enough to open the squelch, and resumes scanning according to the Scan Resume mode set previously.



- To stop scanning, press PTT or  ,  or .

How to Skip (Omit) a Channel During Memory Scanning

As mentioned previously, continuous-carrier stations like broadcast stations inhibit scanner operation if you are using the “Carrier Drop” Scan Resume mode, because the scanner doesn’t resume once it pauses. Such channels can be set to be “skipped” during scanning, if you like:





- Select Memory mode by pressing  , if necessary.
- Press  or , as necessary, to select the memory to be skipped during scanning.
- Press  momentarily (less than 1 second), then press either  or  momentarily. A small ► appears to the left of the memory number, indicating it is to be ignored during scanning.

- Later, to re-enable the memory for scanning, repeat the above three steps.

A memory set to be “skipped” is always accessible via manual memory selection using  or .

Programmable (Band Limit) Memory Scan

This feature allows you to set sub-band limits for either scanning or manual VFO operation. For example, you might wish to set limits (in North America) of 144.300 and 148.000 MHz to prevent encroachment into the SSB/CW “weak signal” portion of the band below 144.300 MHz. Here’s how to do this:

- Select the VFO mode by pressing  , if necessary.
- Using the Memory Storage procedure described earlier, store your lower sub-band limit (144.300 MHz per the above example) into Memory #*lL* (the *l* designates the Lower sub-band limit).
- Likewise, store your upper sub-band limit (e.g., 148.000 MHz) into Memory #*uU* (the *u* designates the Upper sub-band limit).
- Switch to the Memory mode by pressing  once, then press  or  to select Memory #*lL*.
- Turn the Dial one click in either direction. The radio switches to the VFO mode, and the **PS** (“Programmable Scan”) indicator appears in the upper left-hand corner of the LCD.

Scanning

The VX-1R allows you to scan just the stored memories in a band, an entire band, or a selected portion of a band. It pauses on signals encountered, so you can talk to the station(s) on that frequency, if you like.

Scanning operation is basically the same in each of the above modes. Before you begin, take a moment to select the way you want the scanner to *resume scanning* after it halts on a signal.

Setting the Scan Resume Behavior

Two Scan-Resume options are available:



- “5 Second Hold”

In this mode, the scanner pauses any signal for 5 seconds. Unless you push a key within that period, scanning resumes even if a signal is still present.

- “Carrier Drop”

In this mode, the scanner pauses on a signal and remains there until two seconds after the signal is gone (the carrier drops because the station ceases transmission), after which scanning resumes. In the case of continuous signals like broadcasts, the scanner remains paused indefinitely.

To select the Scan-Resume mode:

- Hold  for 1 second to enter the SET mode.
- Press  or  to select Menu Item #8 *RESUME*.







- Turn the Dial to select *5 SEC* or *CARRE* (Carrier Drop), per above description.
- Press  (or the PTT) momentarily to save the new setting and exit to normal operation.



R. F. Says: *The default scan resume setting is 5 SEC.*

VFO Scanning

In this mode you can scan the entire operating band (except the BC band).

- Select the VFO mode by pressing  if necessary.
- Hold  or  for 1 second to start scanning.
- When the scanner encounters a signal strong enough to open the squelch, scanning pauses and the decimal point of the frequency display blinks.
- Scanning then resumes according to the Scan Resume mode selected in the previous section.
- To stop scanning, press PTT or , ,  or .



R. F. Says: *If you press  to start scanning, the VX-1R scans upward. To change the scan direction, turn the Dial one click in the opposite direction (in this case, counter-clockwise). You'll see the scanner turn around and scan downward!*

Alphanumeric Memory Labels

A handy feature of the memory system is the ability to assign a "Label" of up to six letters or numbers to any memory. The storage procedure is easy!

Activate the Memory mode, and select the memory to be labeled.

Hold  for 1 second to enter the SET mode.

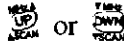
Press  until Menu Item #3 *NAME SET* is selected (this stands for "Name Set").

After a couple of seconds, the frequency display changes to "-- -- -- --", with the left dash blinking. Turn the Dial to select the letter or number you wish to store as the first digit of the Memory Label (see the VX-1R Character Set at the right).

When you have chosen the first letter/number, press  momentarily. This stores the first digit location, and moves the blinking dash to the second slot.

Again turn the Dial to select the letter or number you want to appear in the second position in the Label. When the choice has been made, again press . Repeat this step to enter the rest of the Label.

If you make a mistake, press . All digits to the right of the current position are erased, and you can

correct them. To store a blank space, select the  character.

When you have completed the label, Press  momentarily to accept it.

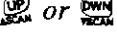

R. F. Says: *Storing a label automatically switches over the frequency display for that channel to the Label (but only that channel).*

*If you wish to restore the frequency display, hold  for 1 second to enter the SET mode, press  to select Menu Item #2 *NAME*, then turn the Dial to choose *FREQ* instead of *ALPHA* on the LCD. This only affects the current memory.*



When switching bands, the frequency of a labeled memory appears for a second before the label appears. You can also check the frequency of a labeled memory just by pressing  twice.

VX-1R Character Set

(spc)	<	>	+	-	=	/	Δ	∇	Σ	∫
	1	2	3	4	5	6	7	8	9	0
	A	B	C	D	E	F	G	H	I	J
	K	L	M	N	O	P	Q	R	S	T
	U	V	W	X	Y	Z				

Loading a Memory into the VFO



You can easily select a memory and use that frequency as a starting point for VFO operation.

- Press  to activate the memory mode, if necessary.
- Press  or  to select the memory whose frequency which you wish copy to the VFO.
- Turn the Dial to switch to the VFO mode.

You can now turn the Dial to tune around the original memorized frequency. The memory contents are unaffected, but the previous VFO frequency on the current band is overwritten by this action.

Changing the Contents of a Memory

You can easily replace the contents of a memory with new data.

- With the radio in Memory mode, select the memory to be changed using  or .
- Turn the Dial in either direction. As in the previous procedure, the radio switches to the VFO mode, and you can select a new frequency to be stored.
- Enter any new CTCSS/DCS tone information needed, and confirm that the repeater shift (if any) is appropriate.
- Hold  for 1 second. The memory number changes to the highest-numbered empty memory, so you must turn the Dial to select the original channel number (which will be blinking).





- Press  momentarily to save the new frequency data. You are still in the VFO mode, and may resume normal operation.



R. F. Says: *When you replace memory data, any Alphanumeric Label (page 35) appended to that channel is erased.*

Masking Memories

There may be situations where you want to “Mask” memories so that they are not visible during memory selection or scanning. For example, several memories used only in a city you visit infrequently may be stored and then “Masked” until you visit that city, at which time you can “Unmask” them for normal use.

- Press  to activate the memory mode, if necessary.
- Hold  for 1 second, then turn the Dial to select the memory to be masked.
- Now press  momentarily. The current memory disappears, and memory operation reverts to that band’s Home channel.
- To unmask the hidden memory, from the Memory mode press  for 1 second, turn the Dial to chose the masked memory’s number, and press  momentarily. The data is restored to operation.



R. F. Says: *Watch out! You can manually store data over a “masked” memory, deleting previous data! Use the “next available free memory” technique to skip over masked memories.*

Hold **[M]** for 1 second so the **[H]** icon blinks and a memory number appears above the frequency display. The next step must be done within 5 seconds while **[H]** is blinking.

Turn the Dial to select the memory number to store the receive frequency, and press **[M]** momentarily. Remember this memory number, as you will need to select it again below.

Now turn the Dial to the desired *transmit* frequency.

Again hold **[M]** for 1 second so the **[H]** icon blinks and a memory number appears, and turn the Dial to select the same memory you stored the receive frequency in, which will be blinking. The next step also must be done within 5 seconds while **[H]** is blinking.

Hold the PTT switch while pressing **[M]** momentarily.

During memory storage, pressing the PTT switch does not cause transmission; rather, it signals the radio's microprocessor that a transmit frequency is being stored.

Memory storage is now complete. When you recall a memory containing independent Tx/Rx data per this section, you will notice that the repeater offset is shown as **[]**, indicating that the pre-programmed default offset is not in use.

"Home" Channel Memories

Each band includes a special "Home" Memory where operation initially begins. These channels have been preset at the factory to the frequencies shown in the chart below. When the VX-1R memories are configured for Group 1, you can store a different frequency for the Home Channel, if you like.

Default Home Channels (MHz)

FM	80.000	ACT 1	380.000
AIR	128.800	U-HAM	433.000
V-HAM	145.000	UHF-TV	649.750
VHF-TV	175.750	ACT 2	860.000



R. F. Says: *To set the Home Channel to a different frequency, after you press the **[M]** key for 1 second, turn the Dial so that H appears as the Memory number; indicating the "Home" Channel.*

Remember, you can't change the Home Channel when configured for Memory Group 2, or if you've set it to be the "Priority" Channel (page 38).

downloaded by
www.radioamatore.info

Hold **[M]** for 1 second. The **[M]** icon in the lower left corner of the LCD blinks, and a memory number appears above the frequency display. This is the *lowest-numbered* memory available for storage.

If the automatically selected memory number is acceptable, press **[M]** to store the operating data into the memory. Otherwise, to store the data in a different memory, turn the Dial to select the desired memory number, and press **[M]**. Occupied memories are indicating by blinking of a memory number, while vacant memory numbers do not blink.

Memory No. blinking = occupied

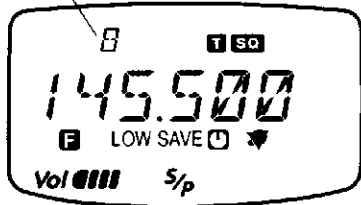

Note that after the last step, the radio is still in the VFO mode, so you can tune around and select other frequencies to store into other memories.

Memory Recall

To recall a memory, press **[SRCH]** momentarily. The transceiver enters the “Memory” mode, using the memories programmed in the previous section.

To select the memories, *do not turn the Dial*. Instead, use **[MEM UP]** or **[MEM DOWN]** to step through the memories on the current band. If you want to select memories on another band, press **[BAND SET]** as needed to select that band, then use **[MEM UP]** or **[MEM DOWN]** to select the memories on that band.



R. F. Says: *If you turn the Dial while in the Memory mode, the radio switches to the VFO mode, using the current memory frequency as the starting point for tuning. This may be convenient for those operating situations when you need to move to avoid interference from other users. Pressing **[SRCH]** returns the radio to the Memory mode. The transceiver remembers the frequency excursion you made, so pressing **[SRCH]** again to return to the VFO mode puts you back where you were after tuning away from the memory frequency!*

Independent Tx/Rx Frequency Storage (“Odd Splits”)

You may need to use a repeater that has a non-standard shift (an offset that does not conform to the local repeater band plan). The VX-1R allows you to store the transmit and receive frequencies independently into a single memory; so you can store the non-standard repeater’s settings without having to change the “standard” repeater shifts in your VX-1R (± 600 kHz, ± 5 MHz, etc.). The procedure is very simple:

- Be sure the transceiver is in the VFO mode. Press **[SRCH]** once to change to VFO operation, if necessary.
- Turn the Dial to the desired receive frequency. Then, as with “Simple Memory Storage” previously, set up all needed CTCSS/DCS tones and modes, but *eliminate* any repeater shift (**[+]** or **[−]** icon) which might be set.

Memory Operation

Your VX-1R's extensive memory system allows storing favorite frequencies for recall later.

You have a choice of two memory configurations, or Groups, from which you can choose the one best suited to your operating needs. These are:

Configuration Group 1: 52 Memories which store simplex or semi-duplex frequencies (including "odd splits") and Tone Mode and Frequency.

Configuration Group 2: 142 "Simplex" Memories which can, nonetheless, store repeater shifts and Tone Mode (but not Tone Frequency).

The Memories in both configurations can store Power Output level, Memory Skip condition and Alphanumeric Memory Labels.

Each configuration also has 10 BC Band memories (unaffected by switching configurations); 10 pairs of "Band Limit" memories, described later under *Programmable Band Scanning* (page 37); and 31 Smart Search Memories, described on page 39.

As shipped from the factory, the memories are configured to Group 1, which provides the most comprehensive memory storage and recall features. If you prefer using the memories to store non-Amateur frequencies and need more than 52 memories (using the VFO mode for Amateur operations), you may wish to switch to Configuration Group 2.

To change Memory Groups, use this procedure:

- Turn the transceiver off by holding in the **PWR** key for 1 second.
- Hold the  key while pressing the **PWR** key to turn the transceiver on. When the radio comes on, **GRP-2** is displayed on the LCD. You can now release the two keys.

Note! Most bands share the same set of memory numbers (1, 2, 3, ...) to simplify the storage process. For example, if a V-HAM channel is stored in Memory 1, Memory 1 is not available on any other band (except BC BAND). So the total number of memories is 52 for Group 1 and 142 for Group 2 (plus 10 for the BC BAND in both Groups), not 52 or 142 per band.

Simple Memory Storage

Storage of frequencies is very simple in the VX-1R. Here are the basic steps:

- Be sure you are in the VFO mode (no memory number shown above the frequency display).
- Turn the Dial to select the desired frequency.
- Important:** Set up any CTCSS/DCS tone conditions you want, along with any needed repeater shift, and transmit power level.

Emergency Channel Operation

The VX-1R includes an "Emergency" feature which may be useful if you have someone monitoring the frequency of your transceiver's UHF "Home" channel. See page 33 for details on setting the Home channel.

The "Emergency" feature:

- (A) sets the radio to the U-HAM band Home channel,
- (B) emits a loud "Alarm" sound (the Volume level is automatically set to maximum), and
- (C) if you press the PTT switch, this alarm sound is transmitted (any repeater shift or tone squelch/-DCS settings are ignored).

You can, for example, use this feature if you are out for a walk and want a quick way of alerting a family member to a dangerous situation. The alarm sound might discourage an attacker and allow you to escape.

The "Emergency" feature is activated (and deactivated) by holding the  key for 2 second.



R. F. Says: *Be sure to arrange with a friend or family member to be monitoring on the same (U-HAM Home) frequency, as no identification is sent via the Emergency alarm sound. Do not transmit the alarm tone except in a true emergency!*

blinks, indicating the digit that is to be entered (“**1**” indicates the end of the DTMF string).

- Turn the Dial to select the first digit of the DTMF string. Selectable entries are *1 ~ 9* and *A ~ F*, with *E* and *F* representing DTMF “*” and “#” tones, respectively.
- Press **[DIAL]** momentarily to accept the first digit and move to the second digit of the DTMF string.
- Repeat the previous step until you have completed the telephone number string.
- Press **[DIAL]** momentarily to store the DTMF Memory. If you wish to confirm the tones by playing them back through the speaker (without transmitting), press the **[ABSET/PTT]** key momentarily.
- To store another number, turn the Dial to select another DTMF Memory, and repeat this process.
- When finished storing DTMF Memories, press **[DIAL]** or the PTT to return to normal display.



R. F. Says: *If you have stored DTMF Memories, but usually use Manual DTMF transmission, you can set the DTMF Memory to **MANU** URL. Then when you key the transmitter and press **[DIAL]**, you automatically bring up the **MANU** setting.*

To send the telephone number:

- Hold the PTT switch to continue transmitting during the following steps.
- Press **[DIAL]** momentarily to enter the DTMF mode.
- Press either **[MEMA UP/LOGAN]** or **[MEMD DOWN/YSOGAN]**, if necessary, to select the DTMF Memory desired. The DTMF Memory number is the small digit at the top left side of the LCD, while the larger digit to the right of **DTMF** in the main display area is *the first digit of the DTMF string*.
- While still holding the PTT switch in, Press **[DIAL]** momentarily to transmit the tone string.

The DTMF code numbers appear on the right side of the LCD as they are transmitted. Once you have pushed the **[DIAL]** key in this step, you can release the PTT switch, as the Autodialer transmits the whole DTMF string automatically.

Sending an Autodial Memory String











DTMF Operation

Despite the lack of a DTMF keypad, you can still transmit DTMF tones with the VX-1R for repeater control or autopatch use.

Manual DTMF Tone Generation

You can generate DTMF tones during transmission manually. The process is somewhat slow, but in an emergency it allows tones to be sent, and with practice you can become proficient in the tone generation procedure:

- Press and hold the PTT switch to continue transmitting during the following steps.
- Press  momentarily. If *MANU*  does not appear on the display, press  or  until it does.
- The number to the *right* of the *MANU* indication is the DTMF number to be sent manually. To send a digit other than 0, turn the Dial to select the number to be sent.
- When you have selected the correct number, press  to send that digit. The tone is transmitted (and sounds quietly in the speaker) for as long as you hold in the  key.
- To send a string of DTMF digits manually, do not release the PTT switch after each tone is sent. Turn the Dial to select another number, then press  again. To send a typical seven-digit telephone

number, therefore, you have to turn the Dial and press  seven times while holding the PTT. Release the PTT switch when you are done; the red TX LED remains lit for about one second before transmission ends.





- Note that the DTMF “*” code is displayed as *E*, and the DTMF “#” code is displayed as *F* on the LCD.





R. F. Says: *If this seems too slow for you, or if it's too slow for the Autopatch system you want to access (the time between tones may be limited) use the DTMF Autodial feature described next.*







DTMF Autodialer

Eight DTMF Autodial memories are provided, allowing you to store telephone numbers for autopatch use. Each memory can hold up to 15 DTMF tones. You can also store short autopatch access code streams to avoid having to send them manually. Here is the DTMF Autodial storage procedure:

- Hold  for 1 second to activate the SET mode.
- Press  or  to select Menu Item #27 *DTMF*.
- Turn the Dial to select the DTMF Memory (1 to 8) in which to store this DTMF string.
- Press  for 1 second to begin entering DTMF digits into the DTMF Memory. The first digit





Changing the Dial's Function

Once you have the memories set up (see the following sections), you may find it easier to use the  and  keys for tuning, and the Dial for volume or squelch control (without having to first press the  key). Here is how to do this:

- Hold  for 1 second to enter the Menu mode.
- Press  or  to select Menu Item #29 *DIAL M.*
- Turn the Dial to select *VOL / SQ* (to use the Dial as a combination Volume/Squelch control), or *DIAL* (to use the Dial as a channel selector—the default).
- Press  again to save the new setting and exit to normal operation.
- If you selected *VOL / SQ* above, turning the Dial causes the display to switch over to Volume level indication. If you first press  and then turn the Dial, the Squelch level changes. In the *VOL / SQ* mode, all frequency control is performed using the  and  keys.

Disabling the Keypad Beeper





If you are operating in a situation where the keypad beep is undesirable, it can be disabled using the Menu System:

- Hold  for 1 second to enter the Menu mode.
- Press  or  to select Menu Item #10 *BEEP.*
- Turn the Dial to select *OFF* on the display.
- Press  momentarily once more to save the new setting and resume normal operation.

Automatic Power-Off (APO) Feature

The APO feature helps conserve battery life by automatically turning the radio off after a user-defined period of disuse. The available time-out period selections are 30 minutes, 1, 3, 5 and 8 hours, or Off (no auto power off).

The default setting for the APO is Off. Here is the procedure for activating it:

- Hold  for 1 second to activate the SET mode.
- Press  or  to select Menu item #13 APO.
- Turn the Dial to select the desired time period after which the radio automatically turns off.
- Once you have made your selection, Press  again momentarily to save the new setting and exit to normal operation.







When the specified period has elapsed, the radio sounds 7 descending-pitch tones from the speaker, and the  icon starts blinking. If you press any key within 1 minute, the icon stops blinking and the APO timer resets. Otherwise, the radio turns off.

Control Locking



To prevent accidental frequency change or inadvertent transmission, the VX-1R's keys and switches can be locked out in various ways. The possible lockout combinations are:

KEY	Just the front panel keys are locked out
DIAL	Just the top panel Dial is locked out
D + K	Both the Dial and Keys are locked out
PTT	The PTT switch is locked (TX not possible)
K + P	Both the keys and PTT switch are locked out
D + P	Both the Dial and PTT switch are locked out
ALL	All of the above are locked out

To lock out some or all of the keys:





- Hold  for 1 second to enter the Menu mode.
- Press  or  to select Menu Item #14 LOCK.
- Turn the Dial to choose between one of the locking schemes listed above.
- When you have made your selection, Press  again to save the new setting and resume normal operation.
- To activate the locking feature, hold the  key for 1 second. The  icon appears on the LCD. To cancel locking, hold the  key again for 1 second.



R. F. Says: *Even when "ALL" keys have been locked out, the Emergency function of the  key and the Unlock function of the  key remain available.*



Busy Channel Lock-Out (BCLO)

The BCLO feature disables the transmitter if another signal is present. When you are using Tone Squelch or DCS, BCLO prevents you from disrupting other communications accidentally (since your radio may be muted by its own decoder). The default setting for the BCLO is OFF, and here is how to change that setting:

- Hold  for 1 second to enter the Menu mode.
- Press  or  to select Menu Item #20 **BCLO**.
- Turn the Dial to set BCLO to **ON**.
- Press  again to save the new setting and resume normal operation.

Receive Battery Saver Setup

An important feature of the VX-1R is its Receive Battery Saver, which “puts the radio to sleep,” periodically “waking it up” to check for activity. If somebody is talking on the channel, the VX-1R remains in the “active” mode until the channel is again quiet, and then resume its “sleep” cycles. This feature significantly reduces quiescent battery drain. You can change the amount of “sleep” time between activity checks using the Menu System:

- Hold  for 1 second to enter the Menu mode.
- Press  or  to select Menu Item #12 **RX SAVE**.

- Turn the Dial to select the desired “sleep” duration. The selections available are 200, 300, and 500 ms, 1 and 2 seconds, or OFF (no sleep). The default value is 200 ms.
- When you have made your selection, Press  again to save the new setting and exit to normal operation.







R. F. Says: *When you are operating on Packet, switch the Receive Battery Saver OFF, as the sleep cycle may overlap the beginning of incoming packets and prevent your TNC from decoding them.*

The Battery Saver does not function on the AM, FM, and TV bands.

Disabling the BUSY/TX LED





Further battery conservation may be accomplished by disabling the BUSY/TX LED. You may want to do this when listening to broadcast stations, since otherwise the LED is on all the time. Use the following procedure:

- Hold  for 1 second to activate the SET mode.
- Press  or  to select Menu Item #16 **BUSY LED**.
- Turn the Dial to change the display from **ON** to **OFF**.
- Press  momentarily to save the new setting and exit to normal operation.

Changing the Transmitter Power Level

You can select between High and Low transmitter power output. The High power level is 100 mW with an "AA" cell, 500 mW with the FNB-52LI, and 1 watt with external 6-V DC applied, while the Low power level is 50 mW with either type of battery, or 200 mW with external DC. **LOW** is displayed below the frequency when selected.





To change the power level:

- Hold  for 1 second to enter the Menu mode.
- Press  or  to select Menu Item #1 *TX PWR*.
- The default power output setting is *HIGH*. To change it to *LOW*, turn the Dial one click until that indication is displayed.
- Press  again to save the new setting and exit.

 **R. F. Says:** *You can set up Low power on one band (like UHF), while leaving VHF on High power, and the radio remembers the different settings on each band. And when you store memories, you can store High and Low power settings separately in each memory, so you don't waste battery power when using very close-in repeaters!*

Transmitter Time-Out Timer (TOT)





The TOT feature provides a safety switch to limit transmission time. This preserves the battery by preventing excessively long transmissions, and in the event of a stuck PTT switch (perhaps if the radio or a Speaker/Mic is wedged between car seats) it can prevent interference to other users as well as battery depletion. As configured at the factory the TOT feature is set to OFF. Here is the procedure for activating it:

- Hold  for 1 second to enter the Menu mode.
- Press  or  to select Menu Item #19 *TOT*.
- Turn the Dial to set the Time-Out Timer to the desired "Maximum Transmit" time (1, 2, 5 or 10 minutes).
- Once you've made the selection you wish to use, Press  again to save the new setting and exit to normal operation.

 **R. F. Says:** *Since brief transmissions are a mark of a good operator, try setting up your radio's TOT feature for a maximum transmission time of 1 minute. This significantly improves battery life, too!*

CTCSS Bell Operation

You can set the VX-1R to “ring” when a signal with a matching CTCSS tone is received during CTCSS Tone Squelch operation. Here is the procedure for activating the CTCSS Bell:





- Set the transceiver up for CTCSS Decode (Tone Squelch) operation, as described on page 20. Notice the  icon displayed near the bottom right whenever Tone Squelch operation is enabled.
- Tune to the desired channel.
- Hold  for 1 second to activate the SET mode.
- Press  or  to select Menu Item #15 *BELL*.
- Turn the Dial to select the desired number of rings. Available choices are 1, 3, 5 or 8 rings, continuous repeating, or Off.
- Press  momentarily to save the new setting and exit to normal operation.

When a station sends a CTCSS tone that matches your selected CTCSS Tone Frequency, the bell rings as programmed, and  flashes at the lower right (so you can tell if someone called while you were away).

When you press the PTT switch to respond, the  stops flashing. However, the ringer does not completely reset for another 5 seconds, so you can conduct your conversation without interruption. When the other station does not respond to you within that period, the ringer resets to respond to the next call.

Tone Calling (1750-Hz Tone Burst)

If the repeaters in your country require a 1750-Hz burst tone for access (typically in Europe), you can set the Monitor switch to serve as a “Tone Call” switch instead. To change the function of this switch, again use the Menu.











- Hold  for 1 second to enter the Menu mode.
- Press  or  to select Menu Item #18 *MON/TC*.
- Turn the Dial to select *T_CALL* on the display.
- Press  again to save the new setting and exit.
- To access a repeater, hold the Monitor switch for the amount of time specified by the repeater owner/operator. The transmitter is automatically activated, and a 1750-Hz audio tone is sent. Once you have accessed the repeater, use the PTT switch to transmit.

Tone Search Scanning

In operating situations where you don't know the CTCSS or DCS tone being used by another station, you can command the radio to *listen* to the incoming signal and *scan* in search of the tone being used. Two things must be remembered in this regard:

- You must be sure that your repeater uses the same tone type (CTCSS vs. DCS).
- Some repeaters do not pass the CTCSS tone; you may have to listen to the station(s) transmitting on the repeater *uplink* (input) frequency in order to allow Tone Search Scanning to work.

To scan for the tone in use:

- Set the radio up for either CTCSS or DCS Decoder operation (pages 20 and 21). In the case of CTCSS, **T S Q** is displayed; in the case of DCS, **DCS** is displayed.
- Hold  for 1 second to enter the Menu mode.
- If operating in the CTCSS Tone Squelch mode, press  or  to select Menu Item #25 **T S E T**, and press  momentarily followed by  or , to start scanning for the incoming CTCSS tone.
- If operating in the DCS mode, use the  or  key to select Menu Item #26 **D C S**, and press  momentarily followed by  or , to start scanning for the incoming DCS tone.

- When the radio detects the correct tone, it halts on that tone, and audio is allowed to pass. Press  again to lock in that tone and exit to normal operation.



R. F. Says: *If the Tone Scan feature does not detect a tone, it continues to scan indefinitely. When this happens, it may be that the other station is not sending any tone. You can press the PTT switch to halt the scan at any time.*

You also can press the Monitor switch during Tone Scanning to listen to the (muted) signal from the other station. Tone Scanning resumes about a second after you release the Monitor switch.





Tone Scanning works either in the VFO or Memory modes.

DCS Operation

Another form of tone access control is Digital Code Squelch, or DCS. It is a newer, more advanced tone system that is less susceptible to false triggering than CTCSS. A DCS encoder/decoder is built into your VX-1R, and operation is very similar to that just described for CTCSS. Although your repeater system may not be configured for DCS, it is frequently quite useful in Simplex operation if your friend(s) use transceivers equipped with this advanced feature.



R.F. Says: Like CTCSS operation, DCS requires that you select a Tone Code and that you set the Tone Mode to DCS.

- Hold  for 1 second to enter the Menu mode.
- Press  or  to select Menu Item #26 DCS.
- Turn the Dial until the display indicates the Tone Code (a three-digit number) you need to be using (ask the repeater owner/operator if your repeater uses DCS and you don't know the tone code). If you are working Simplex, just set up the Tone Code to be the same as that used by your friend(s).
- Press  once (momentarily) to select Menu Item #24 SQUELCH TYP. Turn the Dial so that **DCS** appears in the upper right-hand area of the LCD. This activates the DCS Encoder/Decoder.
- Press  again to save the new setting and exit to normal operation.

DCS Codes

023	025	026	031	032	036*	043	047
051	053	054	065	071	072	073	074
114	115	116	122*	125	131	132	134
143	145*	152	155	156	162	165	172
174	205	212*	223	225	226	243	244
245	246	251	252*	255*	261	263	265
266*	271	274*	306	311	315	325*	331
332*	343	346	351	356*	364	365	371
411	412	413	423	431	432	445	446*
452*	454	455*	462*	464	465	466	503
506*	516	523*	526*	532	546	565	606
612	624	627	631	632	654	662	664
703	712	723	731	732	734	743	754

* Code not available in the Motorola DPL™ system.



R. F. Says: Remember that the DCS is an Encode/Decode system, so your receiver remains muted until a matching DCS code is received on an incoming transmission. Switch the DCS off when you're just tuning around the band!





If you want to scan with DCS enabled, you must first disable ARS (page 18).

CTCSS Operation



Many repeater systems require that a very-low-frequency audio tone be superimposed on your FM carrier in order to activate the repeater. This helps prevent false activation of the repeater by signals from other transmitters. This tone system, called "CTCSS" (Continuous Tone Coded Squelch System), is included in your VX-1R, and is very easy to activate.



R. F. Says: *CTCSS setup involves two actions: setting the Tone Frequency and then setting the Tone Mode. These actions are set up by using Menu items #24 and #25.*

- Hold  for 1 second to enter the Menu mode.
- Press  or  to select Menu Item #25 T SET.
- Turn the Dial until the display indicates the Tone Frequency you need (ask the repeater owner/operator if you don't know the tone frequency).
- Press  once (momentarily) to select Menu Item #24 S QL TYP. Then turn the Dial so that  appears in the upper right-hand area of the LCD; this activates the CTCSS Encoder, which allows repeater access.



R. F. Says: *Rotating the Dial to select the squelch type cycles through  (CTCSS encode),  (Tone SQuelch),  (Digital Code Squelch) and normal (no squelch icon, noise squelch only). Tone Squelch and DCS squelch sys-*

tems mute your VX-1R's receiver until it receives a call from another radio sending out a matching CTCSS tone or DCS code. These systems can help keep your radio quiet until a specific call is received, which may be helpful while operating in congested areas. We'll discuss the Digital Code Squelch system shortly.

- Press  momentarily to save the new setting and exit to normal operation.

CTCSS Tone Selection Table
(frequencies in Hz)

67.0	69.3	71.9	74.4	77.0	79.7	82.5
85.4	88.5	91.5	94.8	97.4	100.0	103.5
107.2	110.9	114.8	118.8	123.0	127.3	131.8
136.5	141.3	146.2	151.4	156.7	162.2	167.9
173.8	179.9	186.2	192.8	203.5	210.7	218.1
225.7	233.6	241.8	250.3			







R. F. Says: *Some repeaters do not re-transmit CTCSS tones—they use CTCSS to control access to the repeater, but don't pass it along when transmitting. If the BUSY/TX LED glows green, but the VX-1R is not passing audio when the repeater is transmitting, you must select CTCSS Encode in the last two steps above, so that only the  appears, allowing you to access the repeater but causing you to hear all traffic on the channel.*

transmit and receive on the same frequency—is selected). When you have the desired shift direction selected, press the PTT momentarily to save your new setting and exit.

Changing the Default Repeater Shifts

If you travel to a different country, you may need to change the default repeater shift to be compatible with local conventions.

To do this, follow the procedure below:

- Select the band for which you want to change the repeater shift.
- Hold  for 1 second to enter the Menu mode.
- Press  or  to select Menu Item #6 *SHIFT*.
- The current shift is displayed on the LCD. Turn the Dial to select the new repeater shift (in 50-kHz steps).
- Press  momentarily to save the new setting and exit.

 **R. F. Says:** *If you just have one “odd” split that you need to program, don’t change the “default” repeater shifts using Menu Item #6! Enter the transmit and receive frequencies separately, as described on page 32.*

Checking the Repeater Uplink Frequency

It often is helpful to be able to check the uplink (input) frequency of a repeater, to see if the calling station is within direct (“Simplex”) range.

To do this, press  momentarily, then hold the Monitor switch below the PTT. You’ll notice that the display has shifted to the repeater uplink frequency. When you release the Monitor switch, operation reverts to normal monitoring of the repeater downlink (output) frequency.



R. F. Says: *If you have a decoder activated (see following sections), it remains active while you check the input frequency.*



downloaded by
www.radioamatore.info

Repeater Operation

Repeater stations, usually located on mountaintops or other high locations, provide a dramatic extension of the communication range for low-powered hand-held or mobile transceivers. The VX-1R includes a number of features that make repeater operation simple and enjoyable.



Repeater Shifts

Your transceiver has been configured, at the factory, for the repeater shifts customary in your country. For the 144-MHz band this usually is 600 kHz, while the 430-MHz shift may be 1.6 MHz, 7.6 MHz or 5 MHz (USA version).

Depending on the part of the band in which you are operating, the repeater shift may be either downward  or upward , and one of these icons appears at the top of the LCD when repeater shift has been enabled.

Automatic Repeater Shift (ARS)

The VX-1R provides a convenient Automatic Repeater Shift feature, which automatically applies the appropriate repeater shift whenever you tune into the designated repeater sub-bands in your country. These sub-bands are shown in the next column.

If the ARS feature does not appear to be working, it may have been disabled. To re-enable ARS, hold  for 1 second, then push  or  to select Menu Item



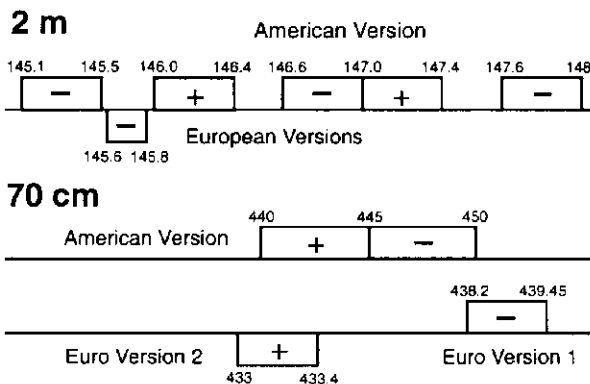

ARS Repeater Subbands



#4 *ARS*. After about 1 second, the current state of this Menu Item appears (*ARS OFF* indicates that the ARS is disabled). Turn the Dial one click to select *ARS ON*, then press  momentarily to save your new setting and exit.

Note: To scan with DCS activated (page 21), you must first disable ARS.

Manual Repeater Shift Activation

When the ARS feature is disabled, you can still set the direction of the repeater shift manually. Hold  for 1 second, then press the  or  key to select Menu Item #5 *RPT R*. Turn the Dial, and you will see that the  or  icon appears at the top of the LCD (when no icon is present, “Simplex” operation—





Advanced Operation



R. F. Says: *Now that you've mastered the basics of VX-1R operation, let's look into some of the really neat features:*





Changing the Channel Steps

The VX-1R's synthesizer provides channels steps of 5/10/12.5/15/20/25 or 100 kHz per step, any number of which may be useful for your requirements. The VX-1R is set up at the factory with default steps on each band which probably are satisfactory for most operation. However, if you need to change the channel step increments, the procedure to do so is very easy.





- Hold the  key for 1 second to enter the Menu mode.
- Press  or  to select Menu Item #7 *STEP*.
- Turn the Dial to select the new channel step size.
- Press  again to save the new setting and exit.

Changing the Operating Mode

The VX-1R provides automatic mode changing when the radio is tuned to different frequencies. However, should an unusual situation arise in which you need to change the operating mode (FM-Narrow, FM-Wide or AM), here is the procedure for doing so:

- Hold  for 1 second to enter the Menu mode.
- Press  or  to select Menu Item #32 *RX MD*.
- Turn the Dial to select the desired operating mode (AM, FM-N, or FM-W).
- Press  again to save the new setting and exit to normal operation.

To Disable the Automatic Mode Switching Feature:

- Hold  for 1 second to enter the Menu mode.
- Press  or  to select Menu Item #31 *AT MD*.
- Turn the Dial to change the display to *OFF* instead of *DN* (the default setting).
- Press  again to save the new setting and exit to normal operation.







R. F. Says: *Unless you have a compelling reason to do so, leave the Automatic Mode Selection feature set to *DN* to save time and trouble when changing bands. If you change the mode of a particular channel or station, you can always store that one channel into memory, as the mode is memorized along with the frequency information.*

Keypad/LCD Light

Your VX-1R includes a pale green lamp which aids in nighttime operation. Three ways of activating the lamp are provided:

- **KEY Mode:** Pressing a key causes the lamp to light for 5 seconds, after which the lamp automatically shuts off.
- **55EE Mode:** Pressing the **PWR** switch momentarily causes the lamp to light for 5 seconds, after which the lamp automatically shuts off.
- **TGL Mode:** Pressing the **PWR** switch momentarily toggles the lamp on and off. The lamp stays lit until you press **PWR** momentarily once more.

Here is the procedure for setting up the Lamp mode:

- You first need to enter the SET (Menu) mode. To do this, hold the  key for 1 second, then release it. All SET mode functions are summarized on page 42.
- Now press either  or  as many times as necessary to select Menu Item #17 **LAMP**.
- Next, turn the Dial to select one of the three modes described above.
- When you have made your choice, press  once more, momentarily this time, to save the new setting for Menu Item #17.

The transceiver returns to normal operation.



R. F. Says: *The 55EE mode offers the greatest battery conservation, as it lights the lamp only when you press the **PWR** switch.*

FM Broadcast/TV Audio Reception

The VX-1R can receive in the FM broadcast band using a wide-bandwidth filter that provides excellent fidelity.

To activate FM Broadcast Reception:

- Press  repeatedly until *FM* appears in the LCD.
- Turn the Dial to select the desired station.

To activate VHF or UHF TV Audio Reception:

- Press  repeatedly until *VHF-TV* or *UHF-TV* appears on the LCD.
- Turn the Dial to select the desired station.

Automatic FM/TV Memory Programming

The VX-1R can automatically find and memorize all FM and TV (VHF and UHF) channels receivable in your area. To do this:

- Press **PWR** to turn the radio Off.
- Hold the  key while turning the radio back On.



The radio scans the FM, VHF-TV and UHF-TV bands, storing all signals it finds in numbered memories (*previously stored memories in these bands are overwritten*). When finished scanning, it switches to the V-HAM band.

- To recall the memories, refer to page 32.
- To delete unwanted memories, refer to page 34.

AM Broadcast Reception

AM Broadcast reception in the 0.5 ~ 1.7 MHz range is also possible on the VX-1R, with 10 special memories just for this band (page 31). However, because of the very low efficiency of the 144/430 MHz antenna provided with the transceiver on this band, this capability is only usable when the antenna is held near a large metal object, or by connecting another antenna more suited for Medium-Frequency reception in place of the supplied antenna.

To Activate AM Broadcast Reception:

- Disconnect the supplied 144/430 MHz antenna, and connect a long-wire or other suitable Medium-Frequency antenna. (If you are within a few miles of an AM broadcasting transmitter, you may be able to pick up sufficient signal by just connecting the radio to the wall charger, or by holding the radio very near a large metal object like a lamp or metal fence.)
- Press  repeatedly until *BC BAND* appears on the LCD.
- Turn the Dial to tune across the AM Broadcast band. The display shows only , but the S/P meter serves as an analog tuning scale.

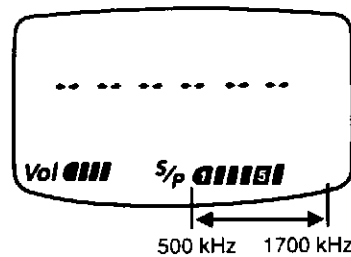

Transmission

Once you have set up an appropriate frequency inside one of the two Amateur bands on which transmission is possible (*V-HAM* or *U-HAM*), you're ready to transmit. These are basic steps; more advanced aspects of transmitter operation are described later.



To transmit, press the PTT switch, and speak into the front panel grille in a normal voice level (be careful not to cover up the microphone with your hand—it's at the upper right corner of the grille). The **BUSY/TX** LED glows red during transmission.

Release the PTT switch to receive.

During transmission, the relative power level is indicated on the *S/P* scale at the lower right. High Power operation (500 mW or 1 W) is indicated by full-scale deflection of the *S/P* Meter, while Low Power opera-

tion (50 mW or 200 mW) is indicated by only three bars on the *S/P* Meter. Low power is also indicated by **LOW** appearing below the frequency display.



R. F. Says: *If you're just talking to friends in the immediate area, you'll get much longer battery life by switching to Low power operation. Press and hold in the  key to enter the SET (Menu) mode, then push  or  to select menu Item #1 TX PWR. If HIGH appears on the LCD, turn the Dial to change the setting to LOW, then press the PTT switch momentarily to save the new setting and exit to normal operation.*

And don't forget: always have an antenna connected when you transmit!

Transmission is possible only on the 2-meter (144-MHz) and 70-centimeter (430-MHz) amateur bands.

Operating Bands

Display	Band	Freq. range (MHz)	kHz step	Mode
BC BAND	AM Broadcast	0.5 ~ 1.7	1.5-4	AM
FM	FM Broadcast	76 ~ 108	100	FM-W
AIR	Aircraft	108 ~ 137	20	AM
V-HAM	2-m Ham	137 ~ 170	5	FM-N
VHF-TV	VHF TV	170 ~ 222	100	FM-W
ACT 1	Misc. 1	222 ~ 420	12.5	FM-N
U-HAM	70-cm Ham	420 ~ 470	25	FM-N
UHF-TV	UHF TV	470 ~ 800	100	FM-W
ACT 2	Misc. 2	800 ~ 999	12.5	FM-N

- Two seconds after you stop pressing , the “Band Selection” mode is automatically canceled, and the display reverts to the operating frequency.

Tuning

The VX-1R initially operates in the “VFO” mode, a channelized system which allows free tuning throughout the entire selected Operating Band. You can confirm that you are in the VFO mode by looking above the “Tens-of-MHz” digit of the operating frequency; if no number is visible in the position illustrated, you are in the VFO mode.













Four tuning methods are available on the VX-1R.





- Turn the Dial to tune in the pre-programmed steps established for the current Operating Band.



R. F. Says: *If you don't move around in the pre-programmed channel steps, the radio may be set to the Memory mode. Press the  key until the channel indicator above the frequency display disappears, then try rotating the Dial again.*

- Press the  or  key momentarily to shift frequency upward or downward, respectively, in the same pre-programmed steps as used during Dial tuning.
- Press , followed by one or more presses of the  or  key, to step up or down the band in 1-MHz steps (note the orange MHz labels above the  and  keys, signifying that 1-MHz steps are the alternate function of these keys when  is pressed first).
- Press and hold in  or  for 1 second to start upward or downward scanning of the band.



R. F. Says: *You don't have to press  each time you want to move by 1 MHz. The  icon on the display stays on for five seconds after your last action involving it, so you have time to press  five times, if you like, to move upward 5 MHz. When  disappears, you can turn the Dial to start tuning in the regular channel steps.*





R. F. Says: *If you press the Monitor switch, the little oval area just below the PTT switch on the side of the radio, the Squelch is overridden, and you can then use the background noise to set the volume level, even if there aren't any incoming signals.*

Squelch Adjustment

The VX-1R initially is set to the “Auto-Squelch” mode, which automatically optimizes the Squelch setting to silence background noise under typical operating conditions. We recommend that you initially use the Auto Squelch setting, and only change it if your operating environment causes the squelch to open unnecessarily.

To change the Squelch Setting:

- Press the  key momentarily, then immediately press  (above the **VOL** label, notice the **SQL** label in orange type, signifying that this is the function activated after the  key is pushed).
- The default condition of the Squelch is Auto-Squelch, which is labeled *SQL AUTO* on the display. Turn the Dial clockwise to select from the other options. The first click of the Dial is *SQL OPEN*, which opens the Squelch to pass background noise (as if you had pushed the Monitor switch). Further rotation of the Dial allows manual setting of the squelch threshold, on a scale of 1 to 10. Advance the Dial to the point where the background noise is

just silenced. Turning the Dial to a higher number reduces the sensitivity of the Squelch system to weak signals.

- About two seconds after you stop turning the Dial, the transceiver automatically cancels the Squelch Setting mode, and the display reverts to the operating frequency.



R. F. Says: *If you're operating in an area of high RF activity, you may want to make use of “Tone Squelch” operation with the built-in CTCSS Decoder. This keeps your radio quiet until a call is received from a station sending a matching (subaudible) CTCSS tone. Or if your friend(s) have radios equipped with DCS (Digital Code Squelch) like your VX-1R has, try using that mode for more silent monitoring of busy channels.*

Selecting the Operating Band

The VX-1R covers an incredibly wide frequency range, over which several different operating modes are used. Therefore, the VX-1R's frequency coverage has been divided into different operating bands, each having its own pre-set channel steps and operating modes. You can change the channel steps and operating mode later, if you like (page 17).

To Change Operating Bands:

- Press  repeatedly. Notice the LCD indication change as you press it.

Operation

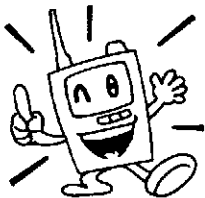

Hi! I'm R. F. Radio, and I'll be helping you along as you learn the many features of the VX-1R. I know you're anxious to get on the air, but I encourage you to read the "Operation" section of this manual as thoroughly as

possible, so you'll get the most out of this fantastic new transceiver. Now, let's get operating!

Getting Started

Switching Power On and Off

- Be sure the battery pack is installed, and that the battery is fully charged. Connect the antenna to the top panel Antenna jack.
- Press and hold in the orange **PWR** switch on the left side of the transceiver about one second. Two beeps sound when the switch has been held in long enough, and the battery voltage appears on the LCD for a few seconds. The frequency then replaces the voltage display. After another two seconds, the Battery Saver function becomes active, unless you have disabled it (page 25).
- To turn the transceiver off, hold the **PWR** switch again for one second.



R. F. Says: *If you've owned a Yaesu handheld before, you'll find that you need to hold in the **PWR** switch for about twice as long as on previous units.*

Also, if you don't hear the two "Beep" tones when the radio comes on, the Beeper may have been disabled via the Menu system. Page 27 tells you how easy it is to re-activate the Beeper.

Adjusting the Volume Level

The volume level is set using a combination of the  key and the Dial on top of the transceiver.

- With the radio on, press the  key momentarily.
- Within two seconds*, turn the Dial to set the volume level on an incoming signal to a pleasant level. If no signals are present, you may wish to pre-set the volume level to "10" on the LCD. There are 31 volume levels available, plus "MUTE," which silences audio output from the speaker. Turning the Dial clockwise increases the volume level.



LCD (Display) Indicators

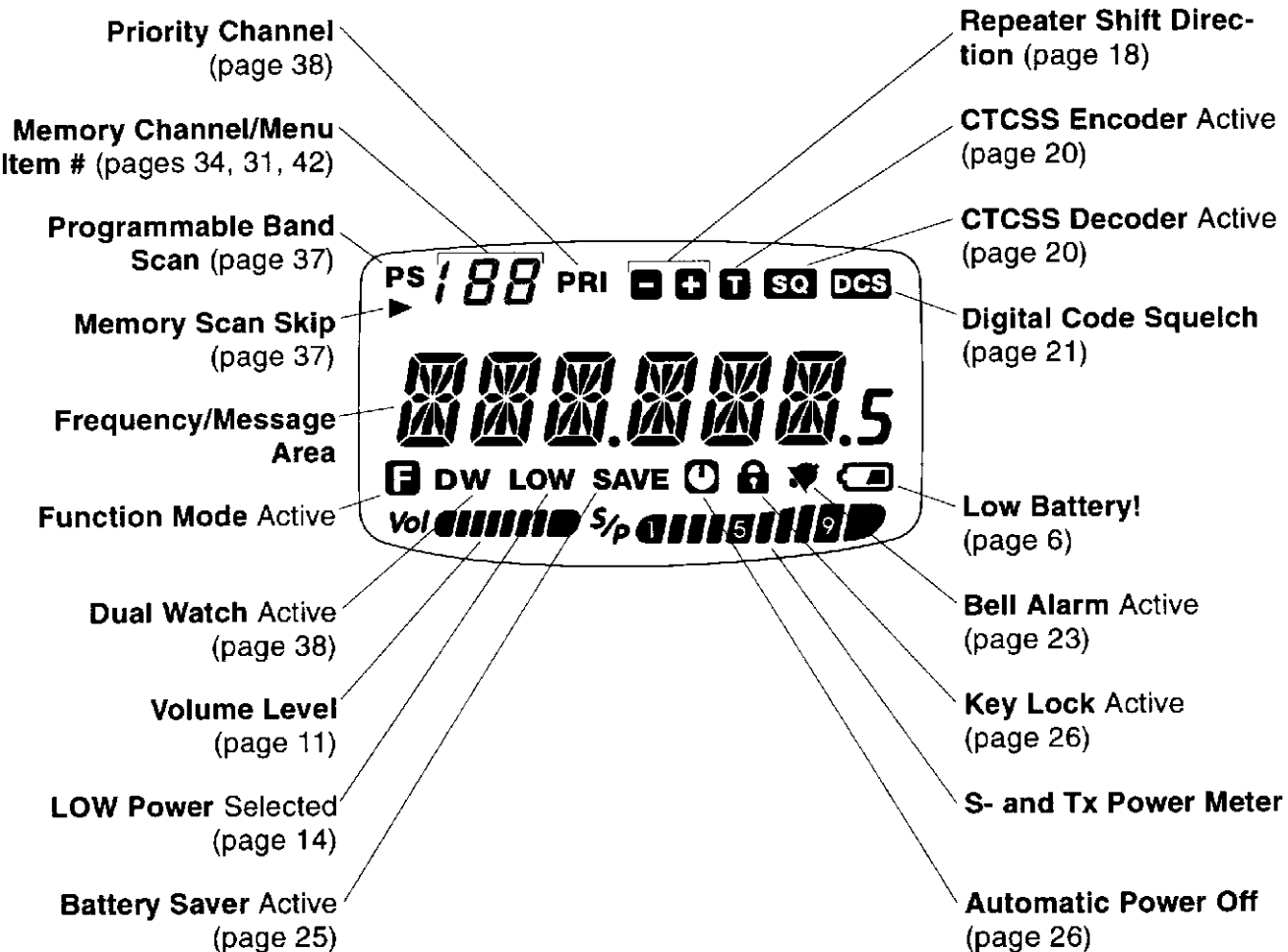

Controls and Connectors

Antenna Jack
(page 4)

PTT Switch
(page 14)

Monitor/Burst Switch
(pages 12, 23)

Volume/Squelch Key
(pages 11 and 12)

Power (PWR) Switch
(page 11)

Function/Memory Write Key

Memory/VFO, Search & Lock key
(pages 31, 34, 39, 26)

External DC Jack
(page 6)

ARTS Set/Enable, Emergency Channel key
(pages 40, 30)

MIC/EAR Jack
(page 44)

Dial
(page 27)

BUSY/TX LED
(page 25)

LCD (Display)
(page 9)

UP/MHz/Scan Key

BAND, Dual Watch, SET Key
(pages 12, 38, 42)

Microphone

DWN/MHz/Scan Key

Speaker

Battery Case/Latch
(page 4)

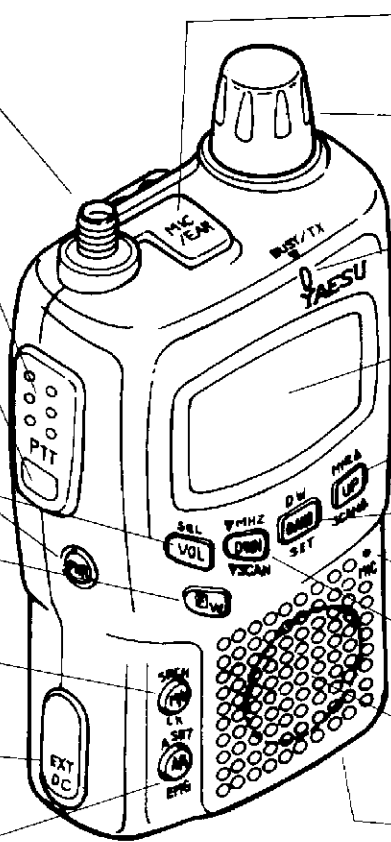

Belt Clip Installation

To install the Belt Clip, first place the loop of the Hand Strap into the groove at the top of the Belt Clip, and run the loop of the strap around the round mounting ridge for the Belt Clip.

Now insert the mounting screw through the belt clip, and affix it snugly to the mounting hole on the back of the transceiver, being careful not to allow the Hand Strap to become misaligned.

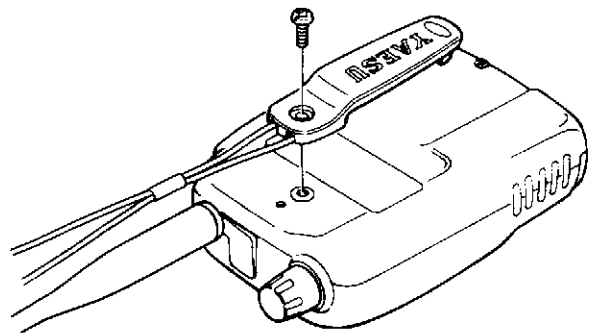
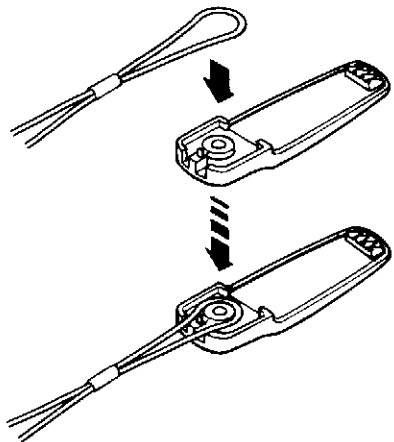



FBA-20 Precautions:

- The FBA-20 is designed for use only with an AA-type alkaline cell.
- If you do not use the VX-1R for a long time, remove the battery from the FBA-20, as battery leakage could cause damage to the FBA-20 and/or the transceiver.
- Avoid touching the electrode area of the bottom plate, as it is *sharp!*
- Even with a fresh battery, the  icon will blink when the PTT switch is pressed.

Battery Life

The VX-1R includes many functions that can be enabled to extend battery charge life, so it is difficult to estimate how long the battery charge will last under all conditions. However, the following table provides some rough approximations under specific conditions. Your mileage is likely to vary.

When the battery is almost depleted,  appears at the lower right corner of the display, indicating that the battery needs recharging or replacement very soon.

If you continue operating, the  icon starts blinking, indicating that battery voltage is *critically* low: the battery should be recharged or replaced at once (or the radio turned off).

VX-1R Battery Life

Operating Band		Operating Time (Hours)	
		FBA-20 (Alkaline)	FNB-52Li (Lithium-Ion)
HAM Bands ⁽¹⁾	VHF	3	14
	UHF	3.5	12
AM (BC, AIR) ⁽²⁾		11	21
FM (incl. TV) ⁽²⁾		6	11

(1) Tx 6 sec., Rx 6 sec. and squelched 48 sec.

(2) Continuous signal reception

The actual battery voltage is displayed briefly when the VX-1R is first switched on, and can be displayed manually on the LCD, by following the instructions on page 46.

Battery capacity may be reduced during extremely cold weather operation. Keeping the radio inside your parka may help preserve the full charge capacity.

AC Operation Using the NC-66B/C/U

The VX-1R can be operated from your house current by use of the supplied NC-66B/C/U AC Adapter.

To use the NC-66B/C/U, turn the transceiver off, then plug the miniature connector of the AC Adapter into the **EXT DC** jack on the side of the radio. Now plug the AC Adapter into the wall outlet. You can now turn on the transceiver. Transmitter power output is 1 watt (High) and 200 mW (Low) in this case.

Re-lock the bottom plate by carefully pressing the hinged latch cover back into its normal operating position.

If the battery has never been used, or if its charge is depleted, it may be charged by connecting the NC-66B/C/U AC Adapter to the **EXT DC** jack for 2 hours. If only 12~24-volt DC power is available, the optional E-DC-15 DC Adapter (with its cigarette lighter plug) may also be used for charging the battery.

The transceiver must be turned off to charge the FNB-52LI battery using the NC-66 or E-DC-15 (the FBA-20 cannot be charged).

Operating the transceiver from the NC-66 allows 1 watt high transmit power, but the battery does not charge while the transceiver is on.

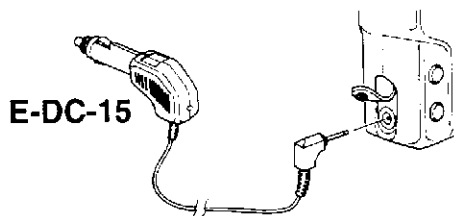
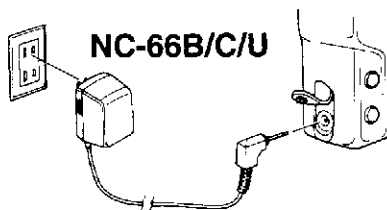

Installing the FBA-20 (Option) Alkaline Battery Case

The optional FBA-20 Battery Case allows receive monitoring using a single "AA" size alkaline battery. An alkaline battery can also be used for transmission in an emergency, but power output is only 100 mW, and battery life is short.

The FBA-20 includes a DC-DC converter which doubles the voltage of the alkaline battery to approximately 3V.

To Install an Alkaline Battery in the FBA-20:

Slide the battery into the FBA-20 so that the negative [-] side of the battery touches the spring contact inside the FBA-20.

Referring to the diagrams on the previous page, unlock the bottom plate by pushing the latch in the **OPEN** direction, and install the FBA-20 as illustrated, with the [+] side facing the bottom of the transceiver.

Re-lock the bottom plate by carefully pressing the hinged latch cover back into its normal operating position.

The FBA-20 does not provide connections for charging, so the NC-66B/C/U or E-DC-15 may safely be connected to the **EXT DC** jack when the FBA-20 is installed.

Installing Accessories

Antenna Installation

The supplied antenna provides good results over the VHF frequency range. For monitoring on the MF Broadcast Band (0.5 ~ 1.7 MHz), we recommend connecting an external antenna.

To install the supplied antenna:

Holding the bottom end of the antenna, screw it onto the mating connector on the transceiver until it is snug. Do not over-tighten.

Antenna Precautions:

- Never transmit without having an antenna connected.
- When installing the supplied antenna, always hold it at the bottom while screwing it onto the transceiver.
- If using an external antenna for transmission, ensure that the SWR presented to the transceiver is 1.5:1 or lower.

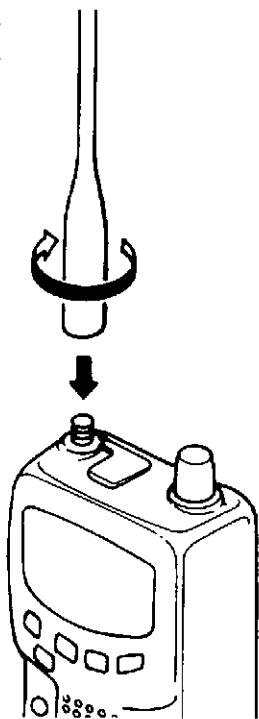

Installing the FNB-52LI Battery Pack

The FNB-52LI is a high-performance 3.6-V Lithium-Ion battery providing 700 mAh capacity yet weighing just over an ounce (33 g.). The FNB-52LI recharges in 2 hours while installed in the radio. Under typical use, the FNB-52LI is good for approximately 300 charge cycles, after which operating time may be expected to decrease. Replace the battery pack with a new one when its charge capacity diminishes.

Unlock the bottom plate by pushing the latch in the **OPEN** direction. You can push the latch with a ball-point pen, if needed.

Install the FNB-52LI as shown below, with the [+] side toward the bottom of the transceiver.

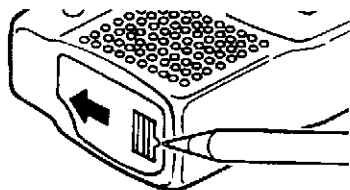

Installing the FNB-52LI or FBA-20

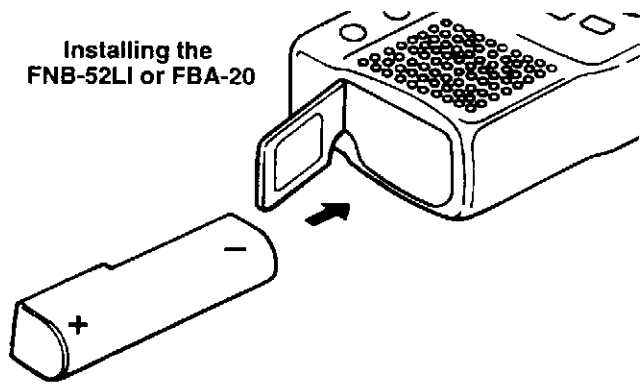

Accessories Supplied with the VX-1R

- FNB-52LI Battery Pack
- NC-66B/C/U AC Power Supply
- Belt Clip
- Hand Strap
- Antenna
- Operating Manual
- Warranty Card

Options for your VX-1R

- FNB-52LI Battery Pack
- NC-66B/C/U AC Power Supply
- FBA-20 Battery Case for LR-6 type Cell
- MH-34B_{4B} Speaker/Microphone
- MH-37A_{4B} Earpiece/Microphone
- VC-25 VOX Headset
- E-DC-15 Cigarette Lighter DC Power Cable
- CSC-71 Soft Case
- CN-3 BNC-to-SMA Adapter
- CT-44 Microphone Adapter

Options

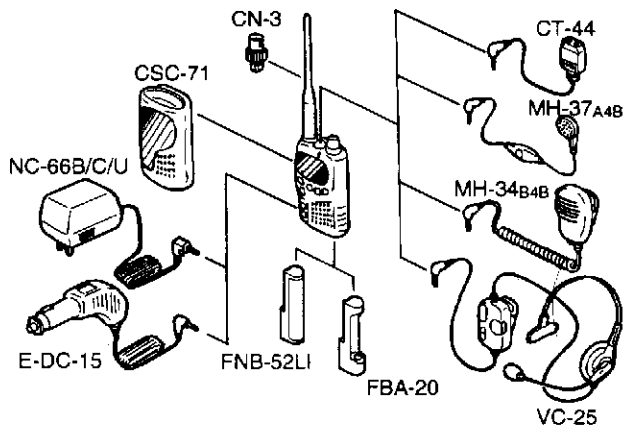

Availability of accessories may vary. Some are supplied as standard per local requirements, while others may be unavailable in some regions. Consult your Yaesu Dealer for details regarding these and any newly available options. Connection of any non-Yaesu-approved accessory, should it cause damage, may void the Limited Warranty on this apparatus.

Specifications

General

Frequency Ranges:

Rx: 0.5 ~ 1.7 MHz ("BC BAND")
76 ~ 108 MHz ("FM")
108 ~ 137 MHz ("AIR")
137 ~ 170 MHz ("V-HAM")
170 ~ 222 MHz ("VHF-TV")
222 ~ 420 MHz ("ACT1"-Action Band 1)
420 ~ 470 MHz ("U-HAM")
470 ~ 800 MHz ("UHF-TV")
800 ~ 999 MHz ("ACT2"-Cellular blocked)

Tx: 144 ~ 146 MHz or 144 ~ 148 MHz
430 ~ 440 MHz or 430 ~ 450 MHz

Channel Steps: 5/10/12.5/15/20/25/50/100 kHz

Frequency Stability: ± 5 ppm (-10°C ~ $+60^{\circ}\text{C}$)

Repeater Shifts (default): ± 600 kHz (VHF)
 $\pm 1.6/5.0/7.6$ MHz (UHF)

Emission Types: F3 (G3E), F2

Antenna Impedance: 50 Ω , unbalanced

Supply Voltage:

Nominal: 3.6 V DC, negative ground
Operating: 3.2 ~ 7.0 V, negative ground (EXT DC jack)

Current Consumption: 150 mA (Receive)
50 mA (Standby, Saver Off)
16 mA (Standby, Saver On)
200 μA (Auto Power Off)
0.4 A (500 mW Tx, VHF/UHF)

Operating Temperature: -20°C ~ $+60^{\circ}\text{C}$

Case Size: 47 \times 81 \times 25 mm (w/o knob, ant.)

Weight: 133 g. (Approx., w/ant. & battery)

Transmitter

RF Power Output: 1W (@ 6V EXT DC IN)
500 mW (@ 3.6 V DC)

Modulation Type: Variable Reactance

Maximum Deviation: ± 5 kHz

Spurious Emissions: At least 50 dB below carrier

Microphone Impedance: 2 k Ω

Receiver

Circuit Type:

Double-Conversion Superheterodyne (VHF/UHF)
Superheterodyne (0.5 ~ 1.7 kHz)

Intermediate Frequencies: 1st: 41.45 MHz (VHF/UHF)
455 kHz (0.5 ~ 1.7 MHz)
2nd: 450 kHz (Narrow FM)
10.7 MHz (Wide FM)

Sensitivity:

Better than: 5 μV for 10 dB S/N (0.5 ~ 1.7 MHz)
1.6 μV for 12 dB SINAD (76 ~ 108 MHz)
0.5 μV for 12 dB SINAD (108 ~ 137 MHz)
0.16 μV for 12 dB SINAD (144 ~ 148 MHz)
15.8 μV for 12 dB SINAD (170 ~ 222 MHz)
0.5 μV for 12 dB SINAD (300 ~ 420 MHz)
0.18 μV for 12 dB SINAD (430 ~ 450 MHz)
15.8 μV for 12 dB SINAD (470 ~ 800 MHz,
except 540 ~ 600)

Better than 5 μV for 12 dB SINAD (800 ~ 999 MHz)

Selectivity ($-6/-60$ dB): 15 kHz/35 kHz (Narrow FM)

AF Output: 50 mW @ 8 Ω for 10% THD (@ 3.6 V DC)

AF Output Impedance: 8 Ω

Specifications are subject to change without notice, and are guaranteed within amateur bands only.

General Description

The VX-1R is a micro-miniature multiband FM transceiver with extensive receive frequency coverage, providing local-area two-way amateur communications along with unmatched monitoring capability.

The VX-1R's incredibly small size allows you to take it anywhere—hiking, skiing, or while walking around town, and its operating flexibility brings the user many avenues of operating enjoyment. Besides 144- and 430-MHz transceive operation, the VX-1R provides receive coverage of the AM and FM broadcast bands, VHF and UHF TV bands, the VHF AM aircraft band, and a wide range of commercial and public safety frequencies!

We appreciate your purchase of the VX-1R, and encourage you to read this manual thoroughly, to learn all about the many fantastic features of your exciting new Yaesu hand-held transceiver!

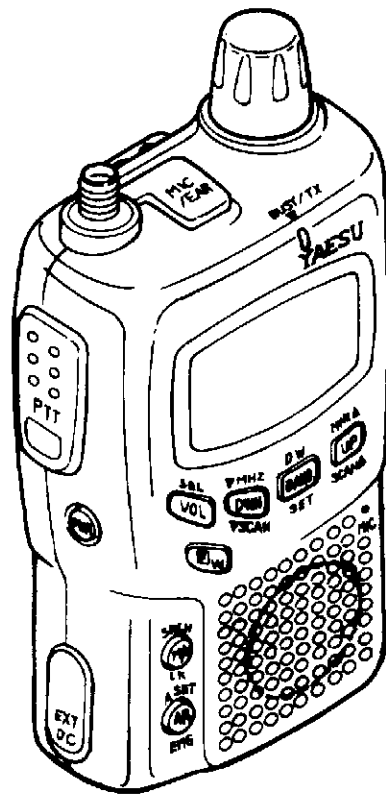

downloaded by
www.radioamatore.info

Contents

General Description	1	Control Locking	26
Specifications	2	Changing the Dial's Function	27
Accessories & Options	3	Disabling the Keypad Beeper	27
Installing Accessories	4	DTMF Operation	28
Battery Life	6	Emergency Channel Operation	30
AC Operation Using the NC-66B/C/U	6	Memory Operation	31
Belt Clip Installation	7	Simple Memory Storage	31
Controls and Connectors	8	Memory Recall	32
LCD (Display) Indicators	9	Independent Tx/Rx Frequency Storage ("Odd Splits")	32
Operation	11	"Home" Channel Memories	33
Getting Started	11	Loading a Memory into the VFO	34
Selecting the Operating Band	12	Changing the Contents of a Memory	34
Tuning	13	Masking Memories	34
Transmission	14	Alphanumeric Memory Labels	35
FM Broadcast/TV Audio Reception	15	Scanning	36
AM Broadcast Reception	15	Setting the Scan Resume Behavior	36
Keypad/LCD Light	16	VFO Scanning	36
Advanced Operation	17	Memory Scanning	37
Changing the Channel Steps	17	Programmable (Band Limit) Memory Scan	37
Changing the Operating Mode	17	Dual Watch (Priority Channel)	38
Repeater Operation	18	Automatic Lamp Lighting on Scan Stop	38
CTCSS Operation	20	Smart Search Operation	39
DCS Operation	21	ARTS (Automatic Range Transpond System)	40
Tone Search Scanning	22	SET (Menu) Function Summary	42
CTCSS Bell Operation	23	Packet Operation	44
Tone Calling (1750-Hz Tone Burst)	23	Cloning	45
Changing the Transmitter Power Level	24	In Case of Trouble	46
Transmitter Time-Out Timer (TOT)	24	Checking the Battery Voltage	46
Busy Channel Lock-Out (BCLO)	25	Antenna Problems	46
Receive Battery Saver Setup	25	Microprocessor Resetting	46
Disabling the BUSY/TX LED	25	Avoiding Internal Spurious Signals ("Birdies")	47
Automatic Power-Off (APO) Feature	26		